

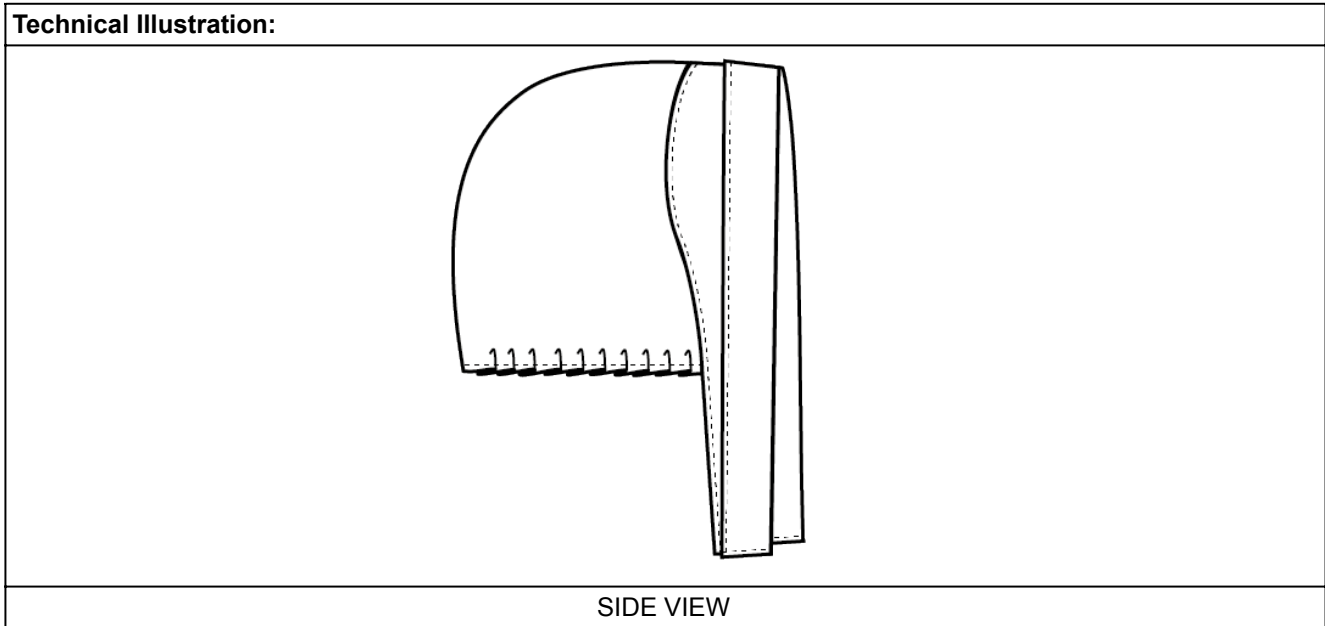





Safety Information		 BURGSCHNEIDER™	
Product:	Bonnet		Size Range: One Size
Modell:	Dagmar		
Item-No.:	040009YC		



Material Composition:
 100% Cotton, Baumwolle, coton, katoen, bomuld, pumpuli, bomull, cotone, algodón, algodão, bawentła, bavlna

Care Instruction:

Machine wash cool, gentle and separately, air dry, do not bleach
 Separat bei 30° im Schonwaschgang waschen, an der Luft trocknen, nicht bleichen
 Laver séparément à 30° en cycle délicat, sécher à l'air, ne pas blanchir
 Lavar por separado a 30° en ciclo delicado, secado al aire, no blanquear

Safety Instruction Product:

Wash before wearing for the first time.
 Only use as intended and not for any other purpose.
 Keep away from sharp and pointed objects.
 Keep away from sparks, open flames and other flammable sources.
 To avoid injury, do not pull the straps too tightly.

Safety Instruction Packaging:
 Plastic bags can be dangerous. To avoid danger of suffocation, keep this bag away from babies and children.

Contact:
 Burgschneider GmbH
 Oberurseler Straße 61-63
 61440 Oberursel (Taunus) DE
 support@burgschneider.com